

RA(R19A)系列翘板开关



技术参数 SPECIFICATION:

安规认证 (safety approval) :UL, CUL, VDE, ENEC, CQC
 电气规格 (Electrical rating) :6A/10A250VAC, 10A/15A125VAC
 机械寿命 (Mechanical life endurance) :30000 cycles
 电器寿命 (Electrical life endurance) :10000 cycles
 接触电阻 (Contact resistance) :<20mΩ
 绝缘电阻 (Insulation resistance) :>1000MΩ
 环境温度 (Ambient temperature) :>T85/T105
 防火等级 (Flammability) :UL94 V-2, UL94 V-0.灼热丝, 针焰测试
 外壳材料 (Material of housing) :PA66
 触电材料 (Contacts) :银合金 (Silver alloy)
 端子材料 (Terminal) :铜镀镍 (Copper silver plated)
 端子焊性 (Solder ability of terminal) :Max 350°C 3S, 用手焊接时, 不可给端子施加压力

料号 Ordering Procedure

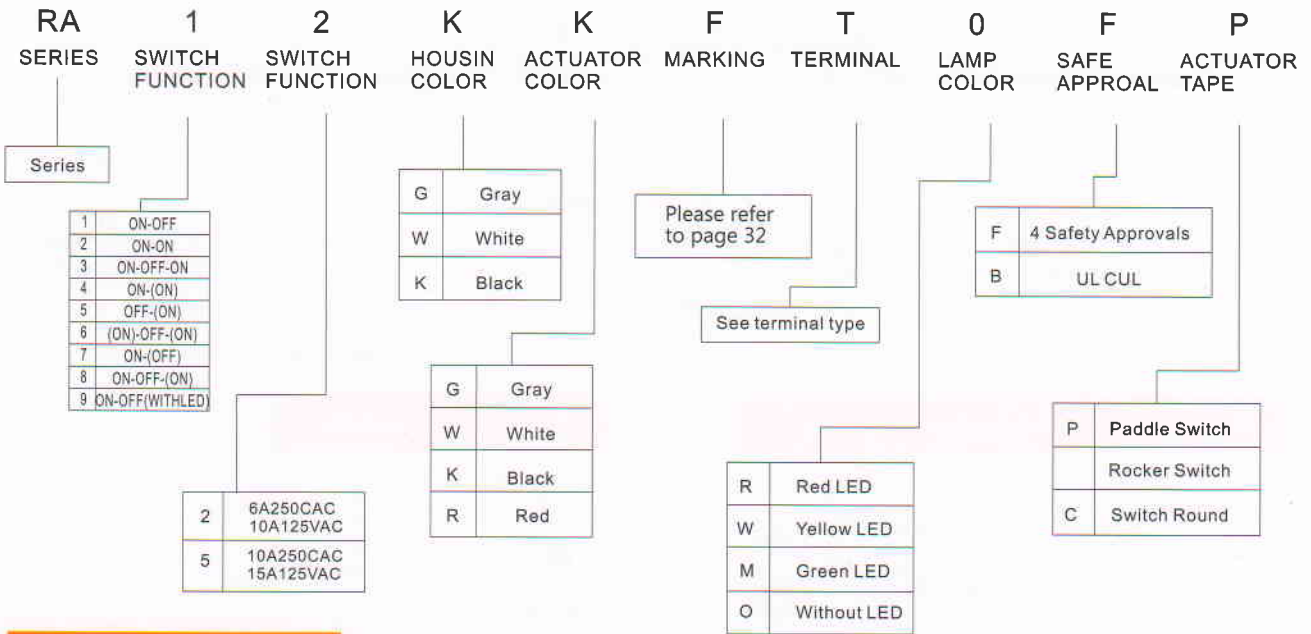

开孔尺寸 Panel Cut Out

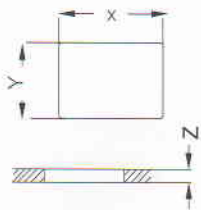

Z	Y	X
0.7~1.25	12.8~12.9	19.2~19.3
1.25~2.0	12.8~12.9	19.3~19.4
2.0~3.0	12.8~12.9	19.5~19.6

印刷符号 Marking List

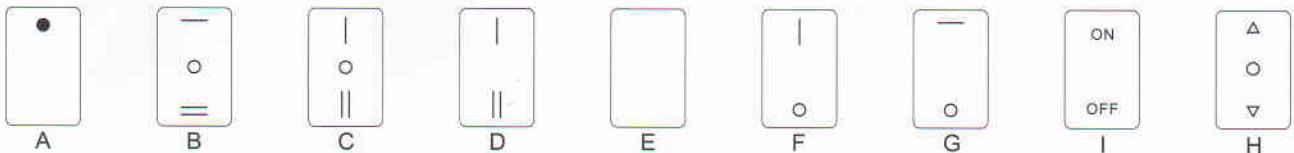

开关功能 Option Of Switch Function

外形尺寸 Dimension:

Item No	POLES & THROWS	Rocker position (>): Momntary		
		Left	Center	Right
Ra1	SPST	ON	None	OFF
Ra2	SPDT	ON	None	ON
Ra3	SPDT	ON	OFF	ON
Ra4	SPDT	ON	None	(ON)
Ra5	SPST	(ON)	None	OFF
Ra6	SPDT	(ON)	OFF	(ON)
Ra7	SPST	ON	None	(OFF)
Ra8	SPDT	ON	OFF	(ON)
Ra9	SPST (With LED)	ON	None	OFF

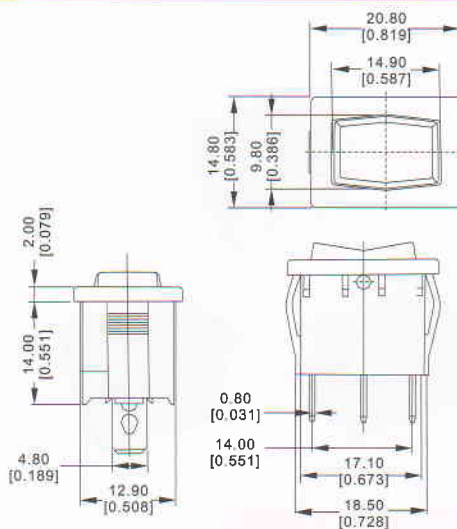

带LED灯开关的电路图 Circuits If Switch With LED

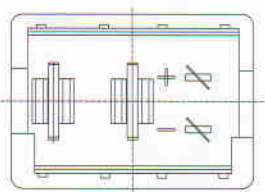

CIRCUIT FOR LOAD

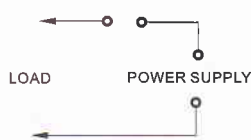

CIRCUIT FOR LED

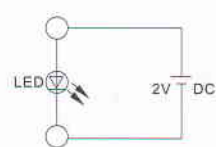

端子类型 Terminal type

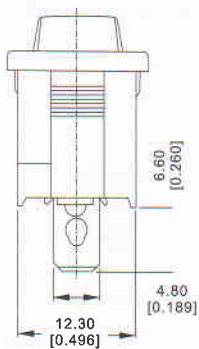

T&H

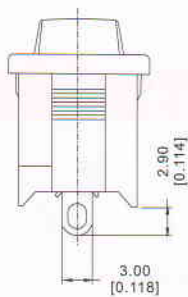

S

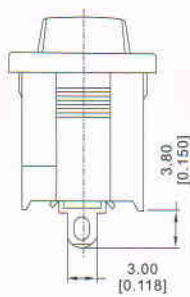

W

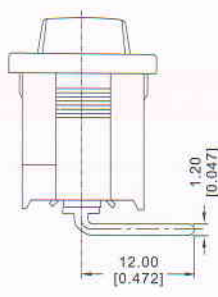

R

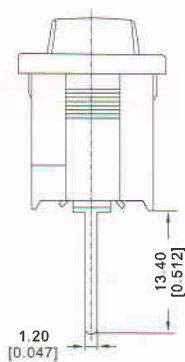

P



RA32KRHT0F



RA12KKFT0F



RA92KKESRF



RA12KKIW0FS



RA12KKIR0FL